



深圳市一众显示科技有限公司

SHEN ZHEN TEAM SOURCE DISPLAY TECH. CO, LTD.

# TFT-LCD Module Specification

**Module NO.:** TST035QVHS-46BC

**Version:** V1.1

APPROVAL FOR SPECIFICATION

APPROVAL FOR SAMPLE

For Customer' s Acceptance:	
Approved by	Comment

Team Source Display:		
Presented by	Reviewed by	Organized by

Version No.	Date	Content	Remark
V1.0	2019-3-21	Initial Release	
V1.1	2019-4-9	更换模组	

**CONTENTS**

**1 GENERAL CHARACTERISTICS..... - 3 -**

**2 PRODUCT DRAWINGS..... - 4 -**

**3 INTERFACE DESCRIPTION..... - 5 -**

    3.1 LCM INTERFACE DESCRIPTION..... - 5 -

    3.2 CTP INTERFACE DESCRIPTION..... - 6 -

**4 LCM INTERFACE TIMING..... - 7 -**

    4.1 RESET TIMING..... - 7 -

    4.2 3-WIRE SERIAL INTERFACE..... - 7 -

    4.3 RGB INTERFACE TIMING..... - 8 -

        4.3.1 *SYNC Mode*..... - 8 -

        4.3.2 *SYNC-DE Mode*..... - 9 -

        4.3.3 *DE Mode*..... - 10 -

        4.3.4 *RGB input timing table*..... - 11 -

**5 ABSOLUTE MAXIMUM RATINGS..... - 12 -**

**6 ELECTRICAL CHARACTERISTICS..... - 12 -**

**7 BACKLIGHT CHARACTERISTICS..... - 12 -**

**8 LCD OPTICAL SPECIFICATIONS..... - 13 -**

**9 CAPACITIVE TOUCH PANEL SPECIFICATIONS..... - 15 -**

    9.1 MECHANICAL CHARACTERISTICS..... - 15 -

    9.2 ELECTRICAL CHARACTERISTICS..... - 15 -

    9.3 INTERFACE TIMING CHARACTERISTICS..... - 15 -

**10 RELIABILITY TEST..... - 16 -**

**11 SUGGESTIONS FOR USING LCD MODULES..... - 17 -**

    11.1 HANDLING OF LCM..... - 17 -

    11.2 STORAGE..... - 17 -

## 1 General Characteristics

ITEM	Specification	Unit
LCD Type	a-Si TFT, Transmissive, Normally black, IPS	-
LCD Size	3.5	inch
Resolution	320 x (RGB) × 240	pixel
LCM (W × H × D )	76.9(W) x 63.9(H) x 4.68(D)	mm
Active Area (W × H)	70.08(W) x 52.56 (H)	mm
Dot size (W × H)	0.073*0.219	mm
Viewing Direction	ALL o'clock	-
Color Depth	16.7M	-
Pixel Arrangement	RGB-stripe	-
Backlight Type	6 LED, 20mA, 18.8V	-
Surface Luminance	450min, 500typ	cd/m <sup>2</sup>
Surface Treatment	Clear	-
Driver IC	ST7272A	-
Interface Type	3SPI/RGB24-bit	-
Input Voltage	3.3	V
TP/Lens	With CTP(FT5316)	-
Weight	TBD	g

**Note 1: RoHS compliant**

**Note 2: LCM weight tolerance: ± 5%.**

## 2 Product drawings

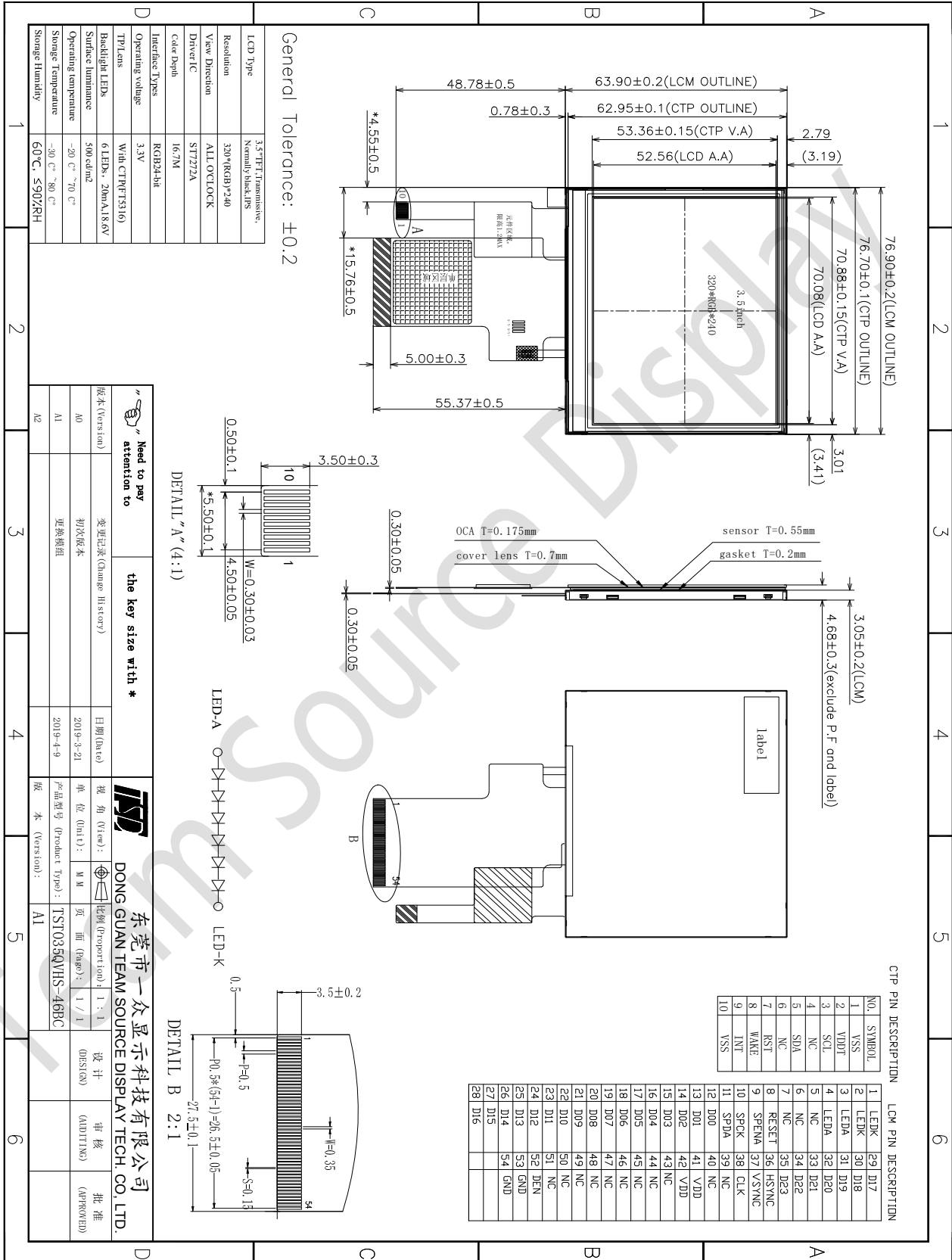

### 3 Interface description

#### 3.1 LCM interface description

Pin No.	Symbol	Description
1-2	LEDK	Cathode of LED backlight.
3-4	LEDA	Anode of LED backlight.
5-7	NC	Not Connection
8	RESET	System reset pin. - An active low pulse at this pin will reset the IC, Connect to VCC in normal operation
9	CS	CS : Chip select pin
10	SCK	Serial clock input
11	SDA	Data input/output pin in serial interface
12~19	B0-B7	Blue Data bus:B0~B7
20~27	G0-G7	Green Data bus:G0~G7
28~35	R0-R7	Red Data bus:R0~R7
36	HSYNC	Line Synchronization input
37	VSYNC	Frame/Ram Write Synchronization input
38	DCLK	Dot-clock signal and oscillator source.
39-40	NC	Not Connection
41-42	VDD	Power supply for digital voltage
43-47	NC	Not Connection
48	X-	Not Connection
49	Y-	Not Connection
50	X+	Not Connection
51	Y+	Not Connection
52	DE	Display enable pin from controller.
53-54	GND	Ground.

### 3.2 CTP interface description

PIN NO.	SYMBOL	DESCRIPTION
1	VSS	Ground
2	VDDT	Power supply 3.3V
3	SCL	I2C clock input
4	NC	Not connect
5	SDA	I2C data signal
6	NC	Not connect
7	RST	Reset pin
8	WAKE	Not connect
9	INT	Interrupt signal from CTP
10	VSS	Ground

## 4 LCM Interface Timing

### 4.1 Reset Timing

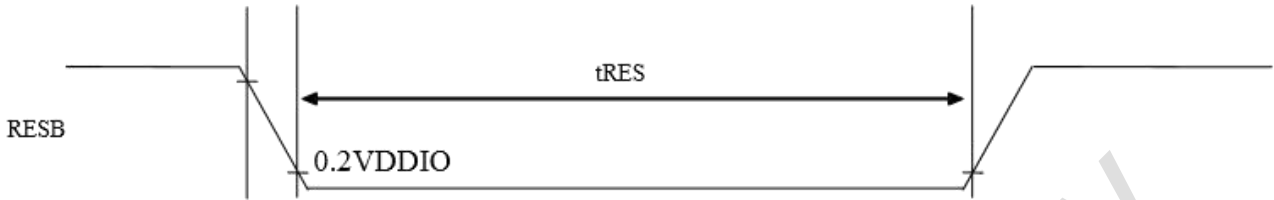

Signal	Parameter	Min	Typ	Max	Unit
nRES	Reset pulse duration	15	-	-	us

### 4.2 3-wire serial interface

R/W: Read/Write mode control bit.  
 R/W=1: Read mode  
 R/W=0: Write mode

Read Mode

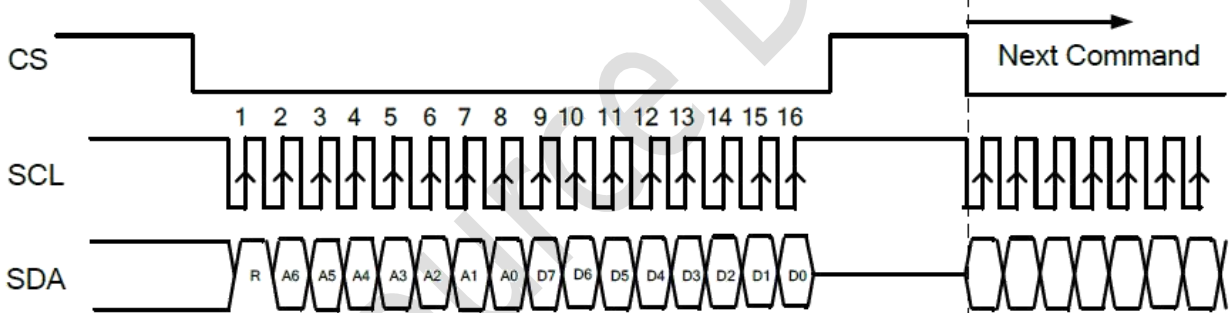

Write Mode

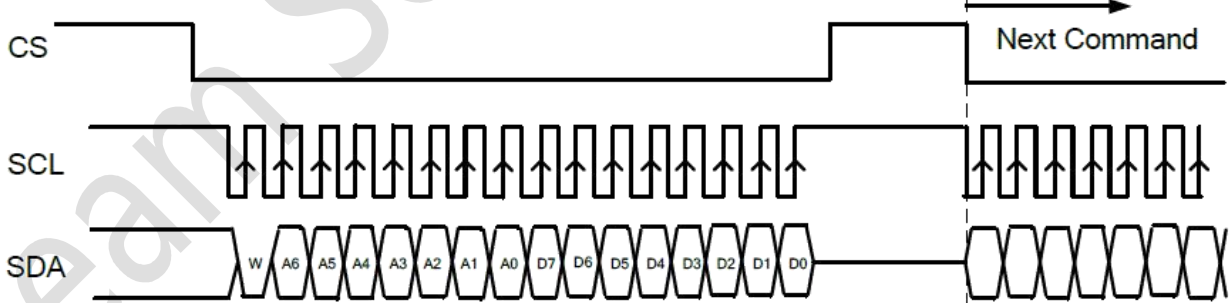

- Each serial command consists of 16 bits of data which is loaded one bit a time at the rising edge of serial clock SCL.
- Command loading operation starts from the falling edge of CS and is completed at the next rising edge of CS.
- The serial control block is operational after power on reset, but commands are established by the VSYNC signal. If command is transferred multiple times for the same register, the last command before the VSYNC signal is valid.
- If less than 16 bits of SCL are input while CS is low, the transferred data is ignored.

- e. If 16 bits or more of SCL are input while CS is low, the previous 16 bits of transferred data before then rising edge of CS pulse are valid data.
- f. Serial block operates with the SCL clock
- g. Serial data can be accepted in the power save mode.
- h. After power on reset or GRB reset, it is required 100ms delay to begin SPI communication.

### 4.3 RGB interface Timing

#### 4.3.1 SYNC Mode

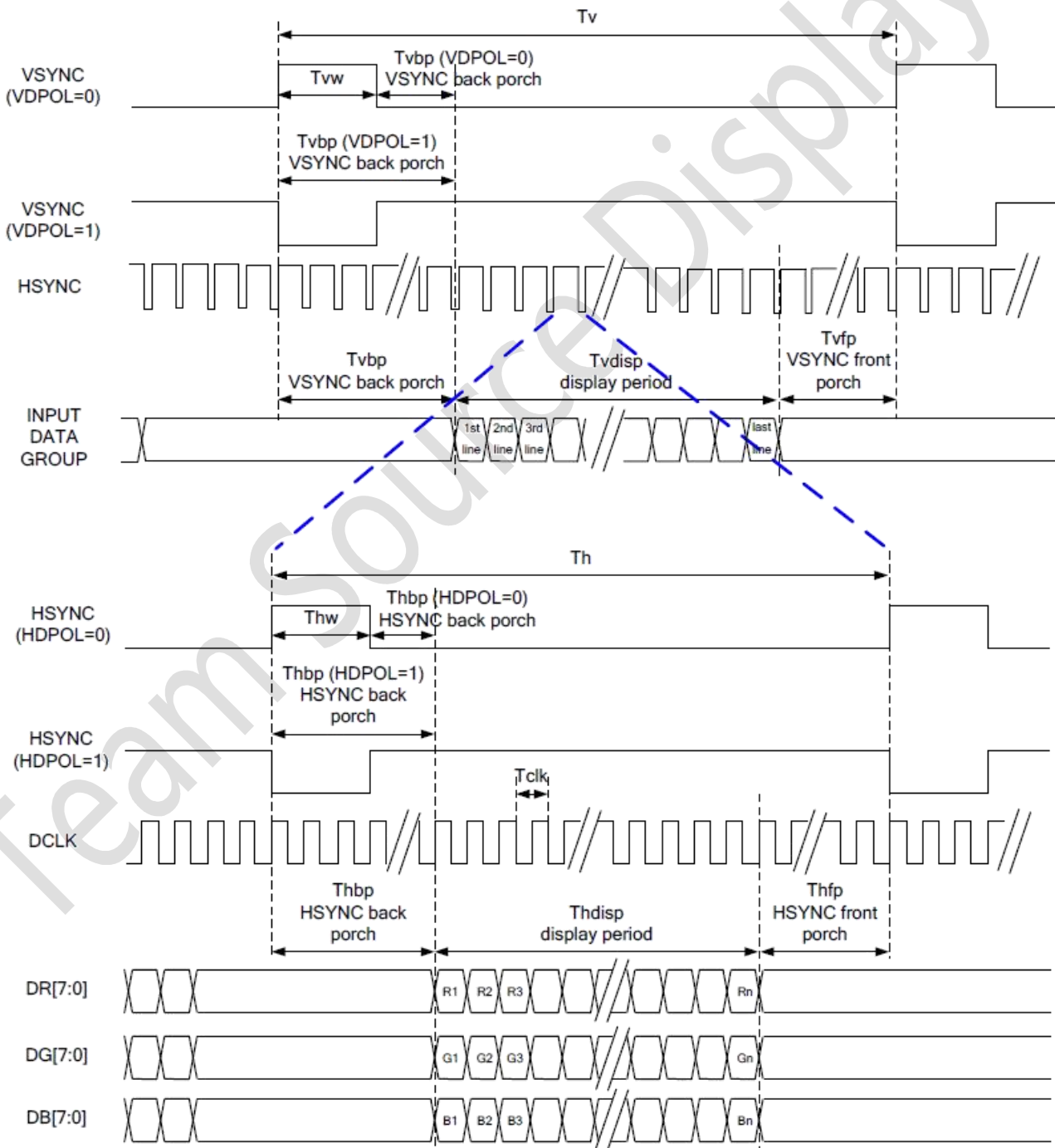



### 4.3.2 SYNC-DE Mode

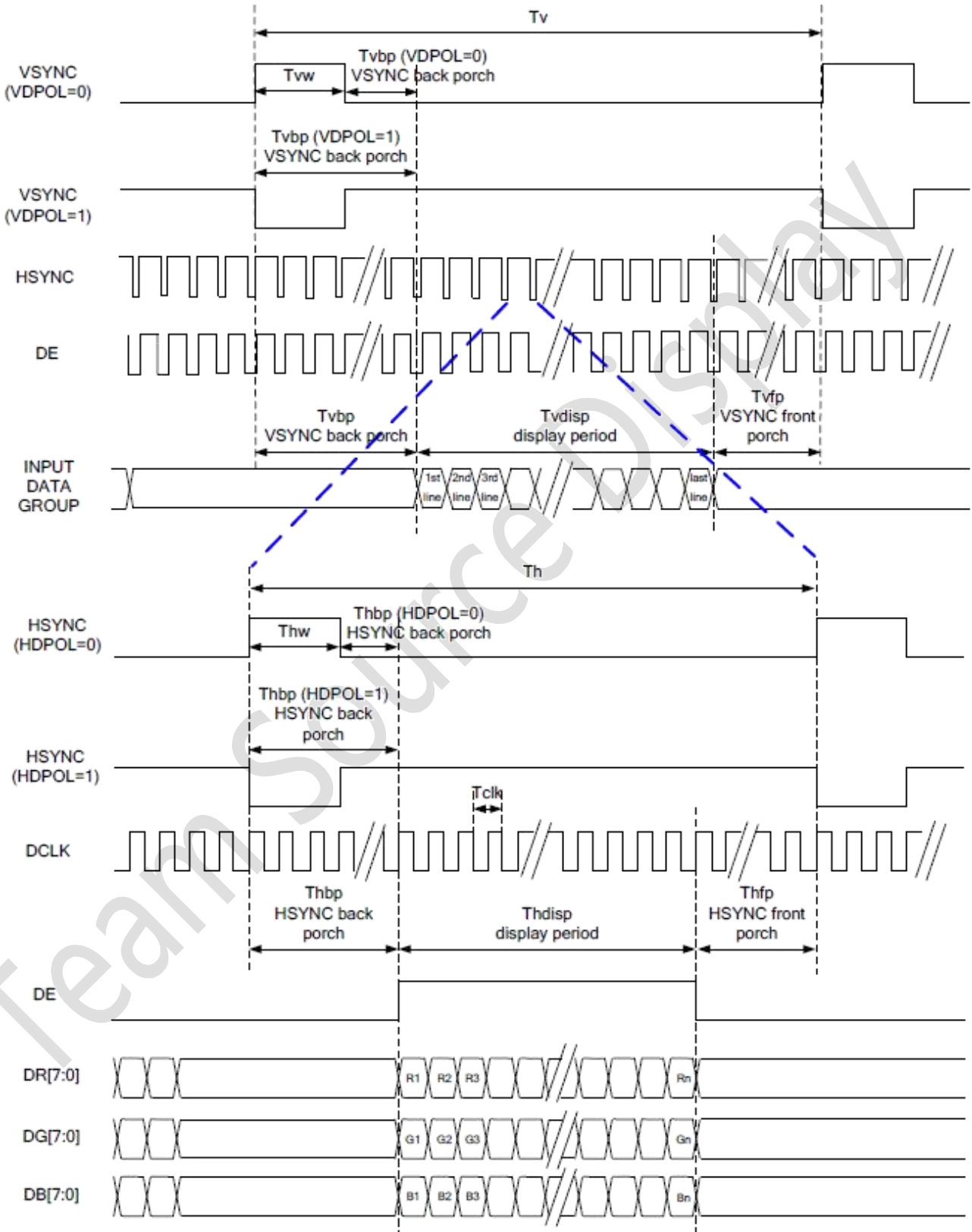

### 4.3.3 DE Mode

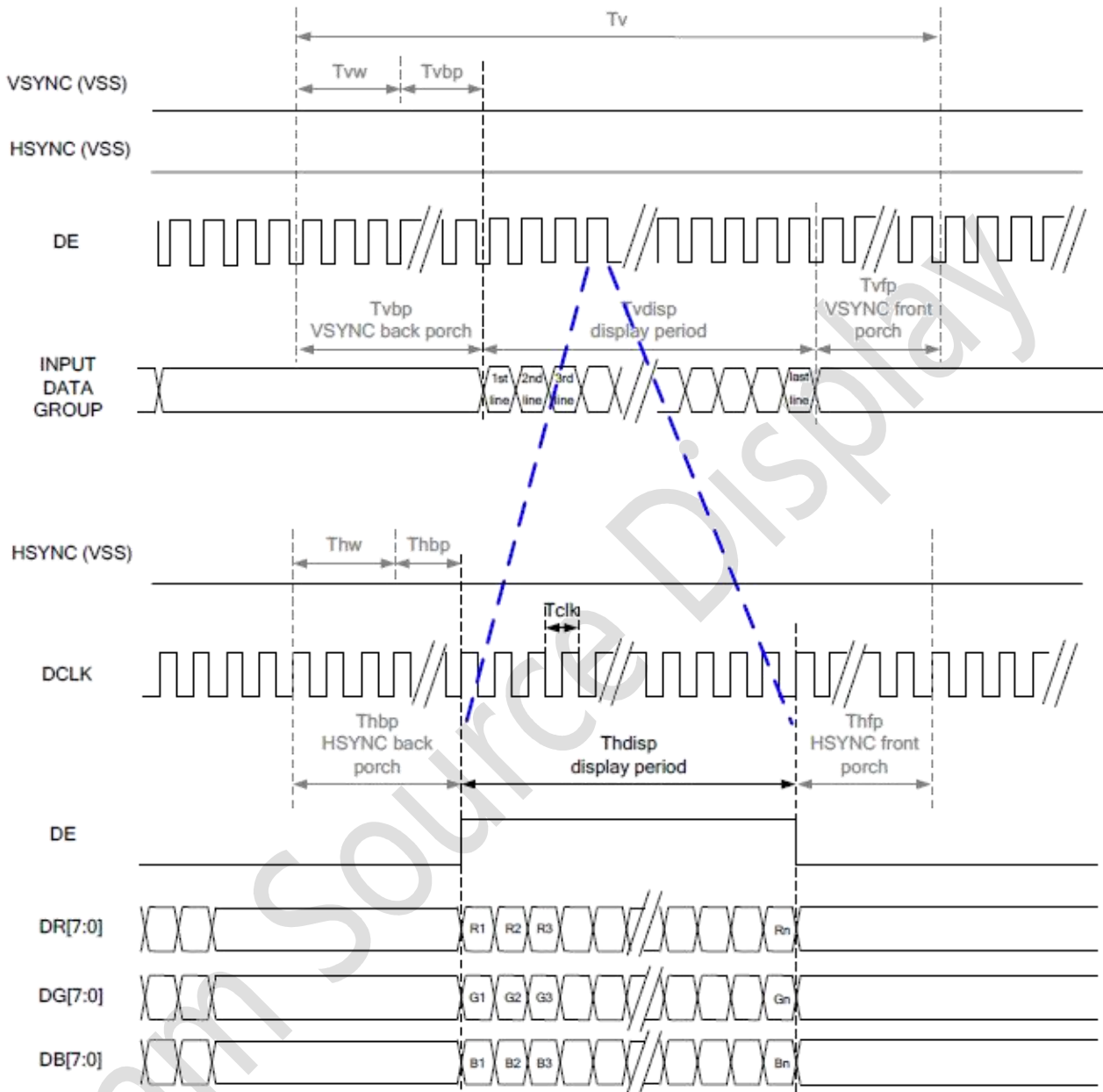

RGB Mode Selection Table	DCLK	HSYNC	VSYNC	DE
SYNC - DE Mode	Input	Input	Input	Input
SYNC Mode	Input	Input	Input	GND
DE Mode	Input	GND	GND	Input

Note: "Input" means these signals are driven by host side.

### 4.3.4 RGB input timing table

Characteristics	Symbol	Min.		Typ.		Max.		Unit
		24 bit	8 bit	24 bit	8 bit	24 bit	8 bit	
DOTCLK Frequency	fDOTCLK	-	-	6.5	19.5	10	30	MHz
DOTCLK Period	tDOTCLK	100	33.3	154	51.3	-	-	ns
Horizontal Frequency (Line)	fH	-		14.9		22.35		KHz
Vertical Frequency (Refresh)	fV	-		60		90		Hz
Horizontal Back Porch	tHBP	-	-	68	204	-	-	tDOTCLK
Horizontal Front Porch	tHFP	-	-	20	60	-	-	tDOTCLK
Horizontal Data Start Point	tHBP	-	-	68	204	-	-	tDOTCLK
Horizontal Blanking Period	tHBP + tHFP	-	-	88	264	-	-	tDOTCLK
Horizontal Display Area	HDISP	-	-	320	960	-	-	tDOTCLK
Horizontal Cycle	Hcycle	-	-	408	1224	450	1350	tDOTCLK
Vertical Back Porch	tVBP	-		18		-		Lines
Vertical Front Porch	tVFP	-		4		-		Lines
Vertical Data Start Point	tVBP	-		18		-		Lines
Vertical Blanking Period	tVBP + tVFP	-		22		-		Lines
Vertical Display Area	NTSC	-		240		-		Lines
	PAL			280(PALM=0)				
	PAL			288(PALM=1)				
Vertical Cycle	NTSC	-		262		350		Lines
	PAL			313				

## 5 Absolute Maximum Ratings

PARAMETER	SYMBOL	MIN	MAX	UNIT
Supply Voltage (Analog)	VDD	-0.3	4.0	V
Logic signal voltage(I/O)	VDDI	-0.3	4.0	V
Operating Temperature	Top	-20	70	° C
Storage Temperature	Tst	-30	80	° C
Operating Ambient Humidity	Hop	10	90%(Max 60° C)	RH

## 6 Electrical Characteristics

PARAMETER	SYMBOL	MIN	TYP	MAX	UNIT
Analog operating voltage	VDD	3.0	3.3	3.6	V
Logic operating voltage	VDDI	3.0	3.3	3.6	V
Input Current	IDD	-	TBD	-	mA
Input Voltage ' H ' level	VIH	0.7VDDI	-	VDDI	V
Input Voltage ' L ' level	VIL	DGND	-	0.3VDDI	
Output Voltage ' H ' level	VOH	VDDI-0.4	-	VDDI	
Output Voltage ' L ' level	VOL	DGND	-	DGND+0.4	

## 7 Backlight Characteristics

ITEM	SYMBOL	MIN	TYP	MAX	UNIT
Voltage for LED backlight	V <sub>f</sub>	-	18.8	-	V
Current for LED backlight	I <sub>f</sub>	-	20	-	mA
Uniformity	Avg	80	-	-	%
LED Life Time	-	30000	40000	-	

Note:

- 1.The LED life time is defined as the module brightness decrease to 50% original brightness at Ta=25°C, 60%RH ±5 %.
2. The life time of LED will be reduced if LED is driven by high current, high ambient temperature and humidity conditions.
3. Typical operating life time is an estimated data.
4. Permanent damage to the device may occur if maximum values are exceeded or reverse voltage is loaded .Functional operation should be restricted to the conditions described under normal operating conditions.

## 8 LCD Optical specifications

Item	Symbol	Condition	Specification			Unit	Remark
			Min	Typ	Max		
Response time (By Quick)	Tr+Tf	-	-	30	40	ms	Note 2
Contrast ratio	CR	-	640	800	-	-	Note 3
Surface luminance	Lv	$\theta=0^\circ$	450	500	-	Cd/m <sup>2</sup>	Note 4
Luminance uniformity	Yu	$\theta=0^\circ$	80	-	-	%	Note 6
Viewing angle	Top	$CR \geq 10$	70	80	-	Deg.	Note 7
	Bottom	$CR \geq 10$	70	80	-		
	Left	$CR \geq 10$	70	80	-		
	Right	$CR \geq 10$	70	80	-		
CIE(x,y) chromaticity	Wx	$\theta=0^\circ$	0.287	0.317	0.347		Note 5
	Wy		0.309	0.339	0.369		

Note 1: Ambient temperature = 25°C.

Note 2: Definition of response time:

The output signals of TRD-100 are measured when the input signals are changed to “White” (falling time) and from “White” to “Black” (rising time), respectively. The interval is between the 10% and 90% of amplitudes. Refer to figure as below.

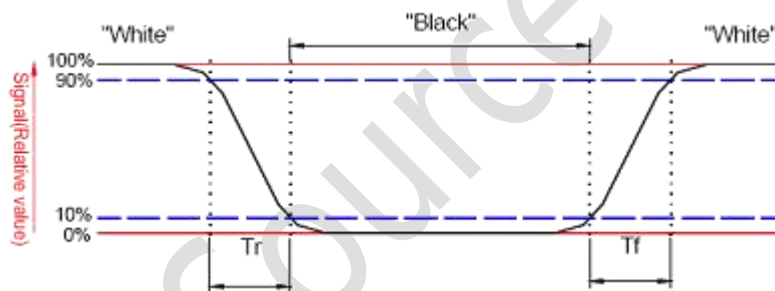

Note 3: Definition of contrast ratio:

Contrast ratio is calculated by the following formula.

$$\text{Contrast ratio (CR)} = \frac{\text{Brightness on the "white" state}}{\text{Brightness on the "black" state}}$$

Measured at the center area of the LCD.

Note 4: Definition of surface luminance

Surface luminance is the luminance with all pixels displaying white

Note 5: For contrast ratio, Surface Luminance, Luminance uniformity and CIE, the testing data is based on TOPCON's BM-7 photo detector or compatible.

Size :  $S \leq 4.3''$  (see Figure A B)

H,V : Active area

Light spot size = 7.7mm (BM-7) 50cm distance or compatible distance from the LCD surface to detector lens.

test spot position : see Figure B.

measurement instrument : TOPCON's luminance meter BM-7 or compatible.

Size : 4.3<S≤12.3” (see Figure A C)

H,V : Active area

Light spot size=7.7mm (BM-7)50cm distance or compatible distance from the LCD surface to detector lens.

test spot position : see Figure C.

measurement instrument : TOPCON’ s luminance meter BM-7 or compatible.

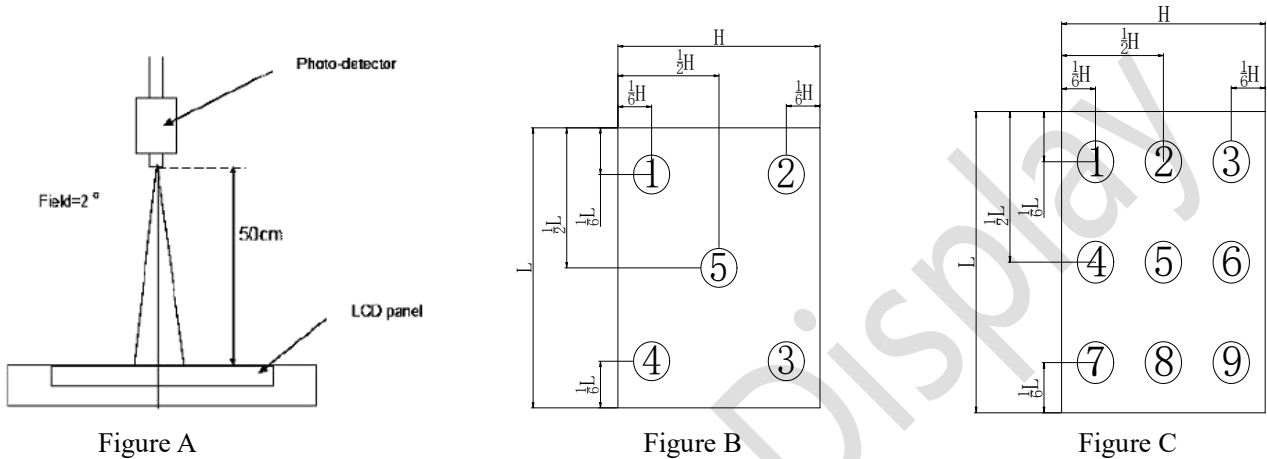

Note 6:Definition of Luminance Uniformity

Active area is divided into 5 or 9 measuring areas,Every measuring point is placed at the center of each measuring area

Bmax: The measured maximum luminance of all measurement position.

Bmin: The measured minimum luminance of all measurement position.

**Luminance Uniformity (Yu)=( Bmin/Bmax)x100%**

Note 7: Definition of viewing angle

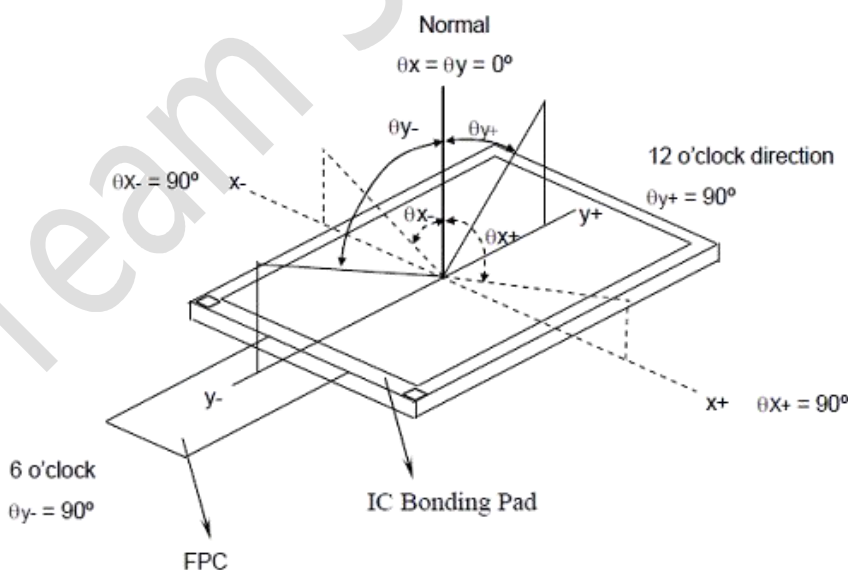

## 9 Capacitive Touch Panel specifications

### 9.1 Mechanical characteristics

DESCRIPTION	INL SPECIFICATION	REMARK
Touch Panel Size	3.5	
Outline Dimension (OD)	76.70(H) x 62.95(V) mm	Cover Lens Outline
Product Thickness	1.59mm	With FPC and frame D.S.T
Glass Thickness	0.7mm	
View Area	70.88x53.36mm	
Input Method	5 Fingers	
Activation Force	Touch	
Surface Hardness	≥6H	

### 9.2 Electrical characteristics

DESCRIPTION	SPECIFICATION
Operating Voltage	DC 2.8~3.3V
Power Consumption (IDD)	Active Mode
	Sleep Mode
Interface	I <sup>2</sup> C
Controller IC	FT5316DME
I <sup>2</sup> C address	0x70
Resolution	320*240

### 9.3 Interface timing characteristics

PARAMETER	MIN	MAX	UNIT
SCL Frequency	-	400K	Hz
Bus Free Time Between a STOP and START Condition	4.7	-	uS
Hold Time (repeated) START Condition	4.0	-	uS
Data Setup Time	250	-	nS
Setup Time for Repeated START Condition	4.7	-	uS
Setup Time for STOP Condition	4.0	-	uS

## 10 RELIABILITY TEST

NO.	TEST ITEM	TEST CONDITION	INSPECTION AFTER TEST
1	High Temperature Storage	80±2°C/96 hours	Inspection after 2~4 hours storage at room temperature and humidity. The condensation is not accepted. The sample shall be free from defects: <ol style="list-style-type: none"> <li>1. Air bubble in the LCD</li> <li>2. Seal leak</li> <li>3. Non-display</li> <li>4. Missing segments</li> <li>5. Glass crack</li> </ol>
2	Low Temperature Storage	-30±2°C/96 hours	
3	High Temperature Operating	70±2°C/96 hours	
4	Low Temperature Operating	-20±2°C/96 hours	
5	Temperature Cycle	-30±2°C ~ 25~ 80± 2°C × 10 cycles (30 min.) (5min.) (30min.)	
6	Damp Proof Test	60°C ±5°C × 90%RH/96 hours	
7	Vibration Test	Frequency 10Hz~55Hz Stroke: 1.5mm Sweep: 10Hz~150 Hz~10Hz 2 hours For each direction of X, Y, Z	
8	Packing Drop Test	Height: 50 cm 1 corner, concrete floor	
9	Electrostatic Discharge Test	C=150pF, R=330 Ω Air: ±8KV 150pF/330Ω 30 times Contact: ±4KV,20 times	



## 11 Suggestions for using LCD modules

### 11.1 Handling of LCM

1. The LCD screen is made of glass. Don't give excessive external shock, or drop from a high place.
2. If the LCD screen is damaged and the liquid crystal leaks out, do not lick and swallow. When the liquid is attach to your hand, skin, cloth etc, wash it off by using soap and water thoroughly and immediately.
3. Don't apply excessive force on the surface of the LCM.
4. If the surface is contaminated, clean it with soft cloth. If the LCM is severely contaminated, use Isopropyl alcohol/Ethyl alcohol to clean. Other solvents may damage the polarizer. The following solvents is especially prohibited: water , ketone Aromatic solvents etc.
5. Exercise care to minimize corrosion of the electrode. Corrosion of the electrodes is accelerated by water droplets, moisture condensation or a current flow in a high-humidity environment.
6. Install the LCD Module by using the mounting holes. When mounting the LCD module make sure it is free of twisting, warping and distortion. In particular, do not forcibly pull or bend the I/O cable or the backlight cable.
7. Don't disassemble the LCM.
8. To prevent destruction of the elements by static electricity, be careful to maintain an optimum work environment.
  - Be sure to ground the body when handling the LCD modules.
  - Tools required for assembling, such as soldering irons, must be properly grounded.
  - To reduce the amount of static electricity generated, do not conduct assembling and other work under dry conditions.
  - The LCD module is coated with a film to protect the display surface. Exercise care when peeling off this protective film since static electricity may be generated.
9. Do not alter, modify or change the the shape of the tab on the metal frame.
10. Do not make extra holes on the printed circuit board, modify its shape or change the positions of components to be attached.
11. Do not damage or modify the pattern writing on the printed circuit board.
12. Absolutely do not modify the zebra rubber strip (conductive rubber) or heat seal connector
13. Except for soldering the interface, do not make any alterations or modifications with a soldering iron.
14. Do not drop, bend or twist LCM.

### 11.2 Storage

1. Store in an ambient temperature of 5 to 45 C, and in a relative humidity of 40% to 60%. Don't expose to sunlight or fluorescent light.
2. Storage in a clean environment, free from dust, active gas, and solvent.
3. Store in antistatic container.

